

Only shining for you



Modern City

Lighting & Electrical Trading LLC



BIG DIPPER

Product Catalog 2023



+971 558 289 347



CONTACT@MODERNCITY.AE



WWW.MODERNCITY.AE

- XL TOWER BUSINESS BAY 12A FLOOR, OFFICE 12A07 -

SCAN HERE



Modern City

Product Catalog 2023



+971 558 289 347



CONTACT@MODERNCITY.AE



WWW.MODERNCITY.AE

- XL TOWER BUSINESS BAY 12A FLOOR, OFFICE 12A07 -



BIG DIPPER

BIG DIPPER series has excellent miniaturized linear design of lamps, so that lighting is properly integrated into the modern decorative design style, to provide users with a variety of functional choices, narrow edge, endless, adjustable Angle, stretching, ceiling, etc., suitable for different lighting places.

2~20W

15°/24°/36°

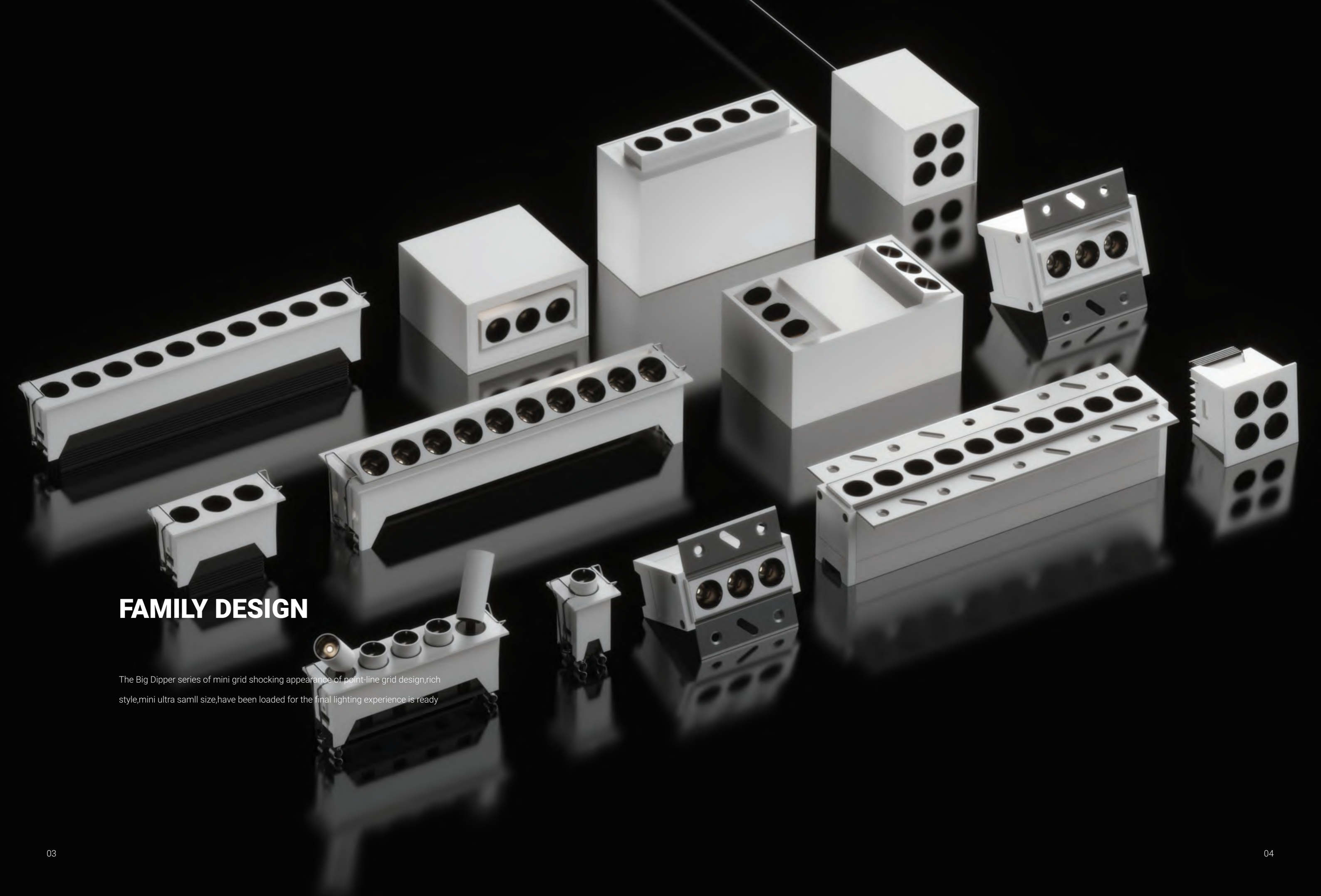

FAMILY DESIGN

The Big Dipper series of mini grid shocking appearance of point-line grid design,rich style,mini ultra samll size,have been loaded for the final lighting experience is ready



Breakthrough lens optical design

Breakthrough lens optical design of a black hole, so that the light reflectors light intersection, define how the light again, don't let the light refraction on the reflectors, matching reflectors of nano-spray technology, black-light technology upgrades!

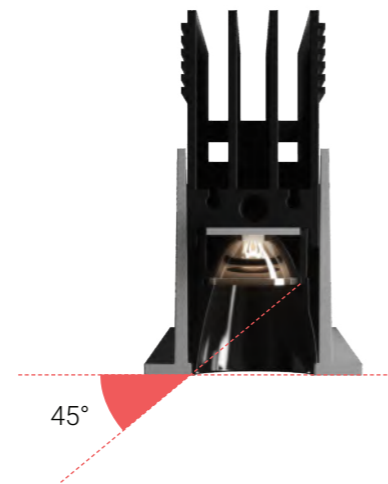

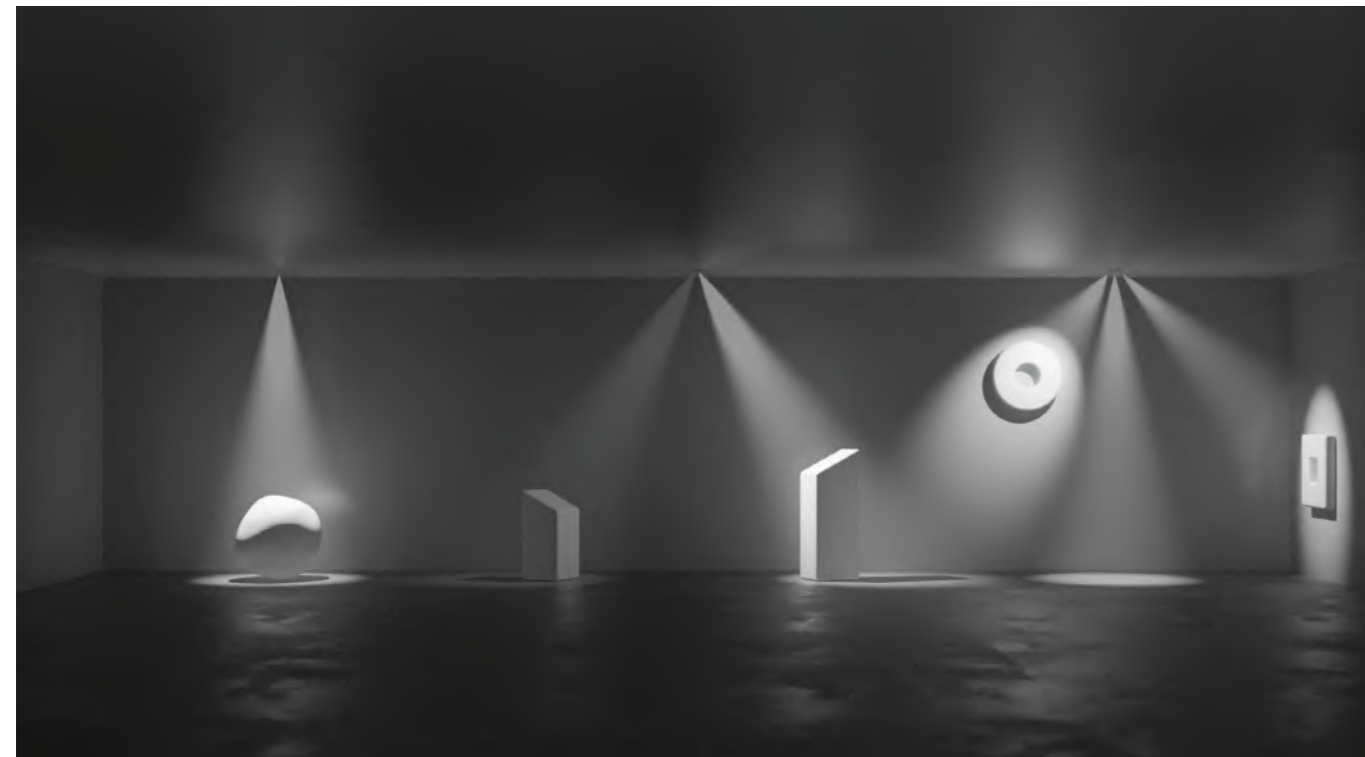
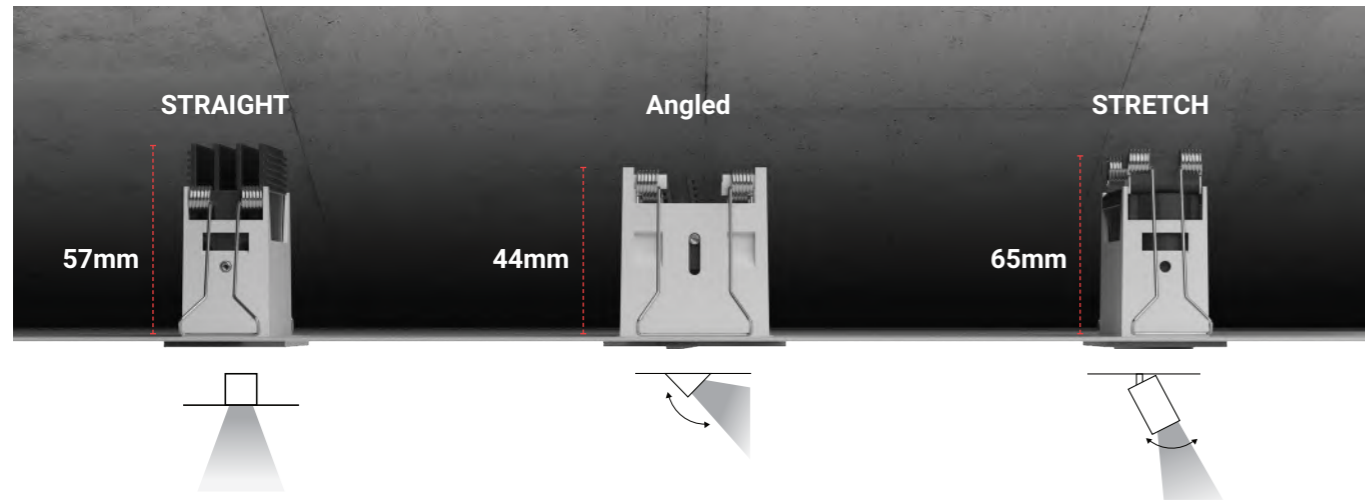

And traditional tube lighting contrast, a high proportion of the Big Dipper has excellent, can adapt to meet a variety of junior high places, card spring structure of the long arm of force, from 1mm sheet metal, multi layer gypsum board to 25mm thick, is easy to control, and ensures easy installation and removal.

Selected for the user to provide a wide range of features: flood, washing walls, directional lights, adjustable corner, stretch, can be freely combined, the application of different places lighting solutions.

Ok

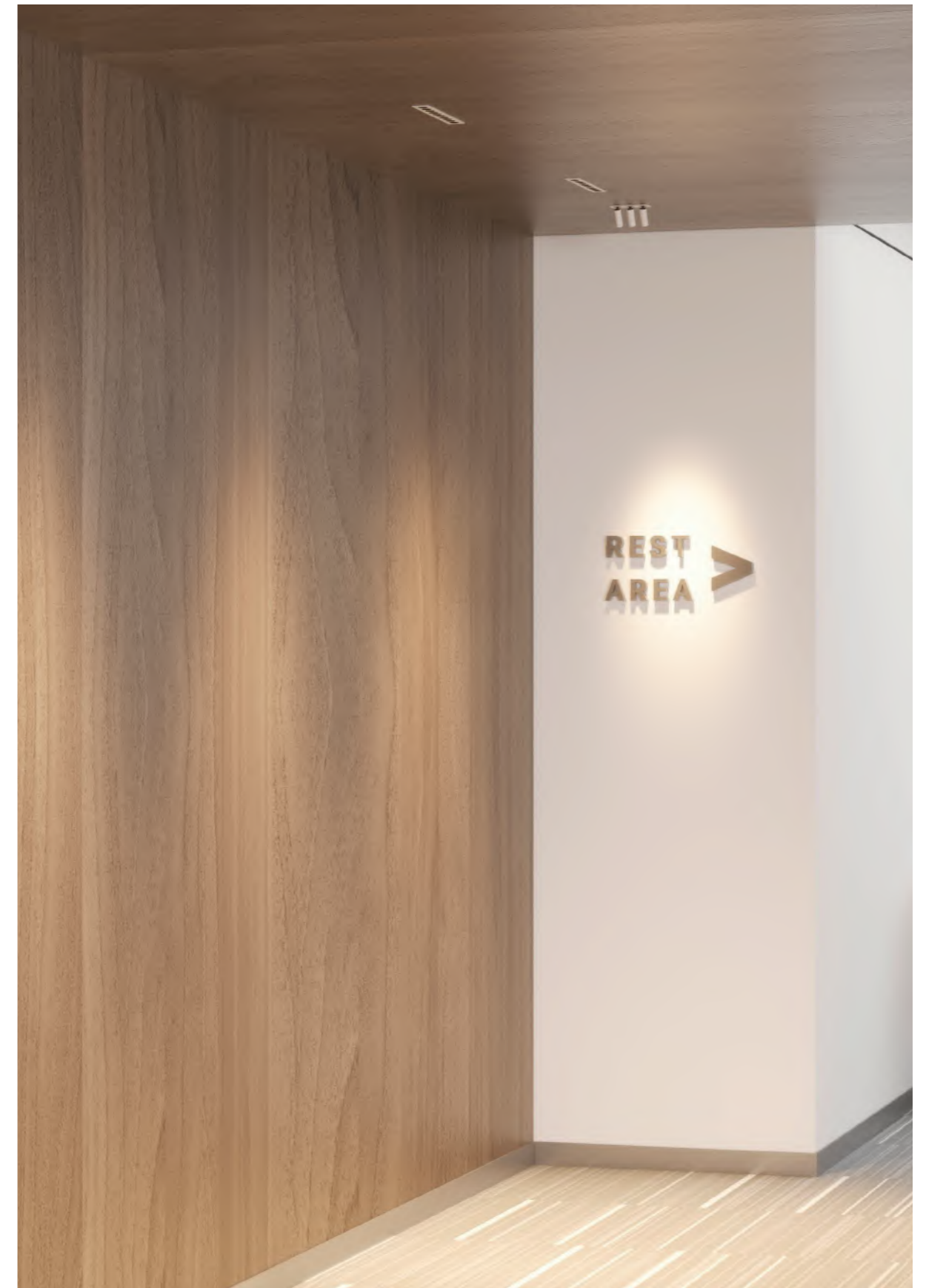

BIG DIPPER



MC0101FS

MC0103FS

MC0105FS

MC0110FS



34x34



25x25

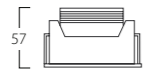

34x81



73x25

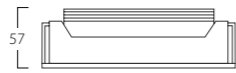

34x127



119x25

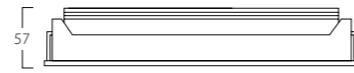

34x242



234x25

UNIT: mm

TECHNICAL DETAILS

Material aluminium	Electrical connection on/off
Optical system opal diffuser	Control
Light source LED COB	Color <input type="radio"/>
Light distributions 	Type of installation Trim

INFORMATION

MC0101FS

Power	Beam angle	CCT	Flux	CRI	Cut-out	Power supply
1x2W	15°	2700K	100lm	95+	25x25mm	3V, 500mA
	24°	3000K				
	36°	3500K				
	4000K					

MC0103FS

Power	Beam angle	CCT	Flux	CRI	Cut-out	Power supply
3x2W	15°	2700K	300lm	95+	73x25mm	9V, 500mA
	24°	3000K				
	36°	3500K				
	4000K					

MC0105FS

Power	Beam angle	CCT	Flux	CRI	Cut-out	Power supply
5x2W	15°	2700K	500lm	95+	119x25mm	15V, 600mA
	24°	3000K				
	36°	3500K				
	4000K					

MC 0110FS

Power	Beam angle	CCT	Flux	CRI	Cut-out	Power supply
10x2W	15°	2700K	1000lm	95+	242x25mm	30V, 600mA
	24°	3000K				
	36°	3500K				
	4000K					



BIG DIPPER



MC0101FST **N**

MC0103FST **N**

MC0105FST **N**

MC0110FST **N**

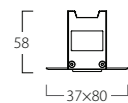

40x40

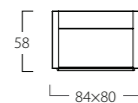

86x40

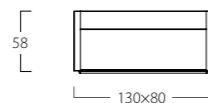

132x40

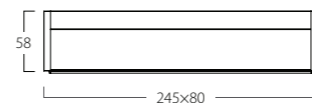

247x40

UNIT: mm

TECHNICAL DETAILS

Material aluminium	Electrical connection on/off
Optical system opal diffusor	Control
Light source LED COB	Color <input type="radio"/>
Light distributions 	Type of installation <input type="checkbox"/> Trimless

INFORMATION

MC0101FST

Power	Beam angle	CCT	Flux	CRI	Cut-out	Power supply
1x2W	15°	2700K	100lm	95+	40x40mm	3V, 500mA
	24°	3000K				
	36°	3500K				
		4000K				

MC0103FST

Power	Beam angle	CCT	Flux	CRI	Cut-out	Power supply
3x2W	15°	2700K	300lm	95+	86x40mm	9V, 500mA
	24°	3000K				
	36°	3500K				
		4000K				

MC0105FST

Power	Beam angle	CCT	Flux	CRI	Cut-out	Power supply
5x2W	15°	2700K	500lm	95+	132x40mm	15V, 600mA
	24°	3000K				
	36°	3500K				
		4000K				

MC0110FST

Power	Beam angle	CCT	Flux	CRI	Cut-out	Power supply
10x2W	15°	2700K	1000lm	95+	247x40mm	30V, 600mA
	24°	3000K				
	36°	3500K				
		4000K				



BIG DIPPER



MC0103AS

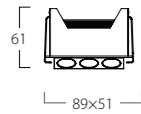

82x44

MC0105AS

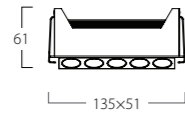

128x44

MC0110AS

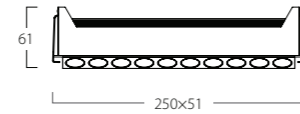

243x44

UNIT: mm

INFORMATION

MC0103AS

Power	Beam angle	CCT	Flux	CRI	Cut-out	Power supply
3x2W	15°	2700K	300lm	95+	94x57mm	9V, 500mA
	24°	3000K				9V, 500mA
	36°	3500K				9V, 500mA
		4000K				9V, 500mA
		2700K-6000K*				18V,300mA*

MC0105AS

Power	Beam angle	CCT	Flux	CRI	Cut-out	Power supply
5x2W	15°	2700K	500lm	95+	140x57mm	15V, 600mA
	24°	3000K				15V, 600mA
	36°	3500K				15V, 600mA
		4000K				15V, 600mA
		2700K-6000K*				30V,300mA*

MC0110AS

Power	Beam angle	CCT	Flux	CRI	Cut-out	Power supply
10*2W	15°	2700K	1000lm	95+	255x57mm	30V, 600mA
	24°	3000K				30V, 600mA
	36°	3500K				30V, 600mA
		4000K				30V, 600mA
		2700K-6000K*				30V,600mA*

TECHNICAL DETAILS

Material aluminium	Electrical connection on/off
Optical system opal diffuser	Control
Light source LED COB	Color <input type="radio"/>
Light distributions 	Type of installation Trim



BIG DIPPER



MC0103AST

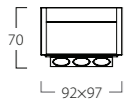

MC0105AST

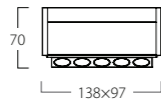

MC0110AST

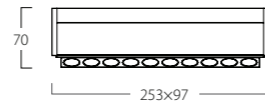

UNIT: mm

INFORMATION

MC0103AST

Power	Beam angle	CCT	Flux	CRI	Cut-out	Power supply
3x2W	15°	2700K	300lm	95+	82x44mm	9V, 500mA
	24°	3000K				9V, 500mA
	36°	3500K				9V, 500mA
		4000K				9V, 500mA
		2700K-6000K*				18V,300mA*

MC0105AST

Power	Beam angle	CCT	Flux	CRI	Cut-out	Power supply
5x2W	15°	2700K	500lm	95+	128x44mm	15V, 600mA
	24°	3000K				15V, 600mA
	36°	3500K				15V, 600mA
		4000K				15V, 600mA
		2700K-6000K*				30V,300mA*

MC0110AST

Power	Beam angle	CCT	Flux	CRI	Cut-out	Power supply
10x2W	15°	2700K	1000lm	95+	243x44mm	30V, 600mA
	24°	3000K				30V, 600mA
	36°	3500K				30V, 600mA
		4000K				30V, 600mA
		2700K-6000K*				30V,600mA*

TECHNICAL DETAILS

Material aluminium	Electrical connection on/off
Optical system opal diffuser	Control
Light source LED COB	Color <input type="radio"/>
Light distributions 	Type of installation <input type="checkbox"/> Trimless



BIG DIPPER



MC0201AS



MC0203AS



MC0205AS

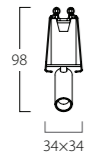

34x34



25x25

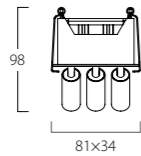

81x34



73x25

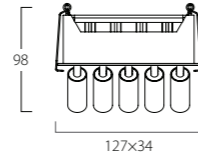

127x34



119x25

UNIT: mm

INFORMATION

MC0201AS

Power	Beam angle	CCT	Flux	CRI	Cut-out	Power supply
1x2W	15°	2700K	100lm	95+	25x25mm	3V, 500mA
	24°	3000K				
	36°	3500K				
	4000K					

MC0203AS

Power	Beam angle	CCT	Flux	CRI	Cut-out	Power supply
3x2W	15°	2700K	300lm	95+	73x25mm	9V, 600mA
	24°	3000K				
	36°	3500K				
	4000K					

MC0205AS

Power	Beam angle	CCT	Flux	CRI	Cut-out	Power supply
5x2W	15°	2700K	500lm	95+	119x25mm	15V, 600mA
	24°	3000K				
	36°	3500K				
	4000K					

TECHNICAL DETAILS

Material aluminium	Electrical connection on/off
Optical system opal diffuser	Control
Light source LED COB	Color <input type="radio"/>
Light distributions 	Type of installation Trim



BIG DIPPE Surface mounted Spotlight



The unique surface mounted product structure can adjust the lighting angle by $\pm 15^\circ$, More flexible application, suitable for popular loft industrial style decoration style.



BIG DIPPER



MC0703AS

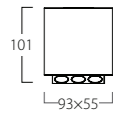

MC0705AS

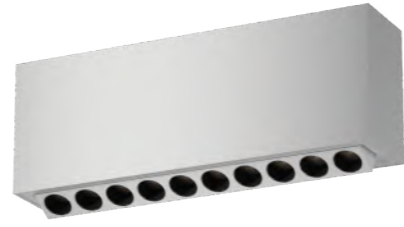
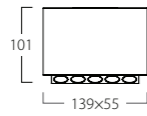

MC0710AS

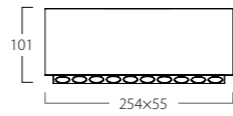

MC0723AS ^N

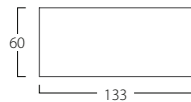
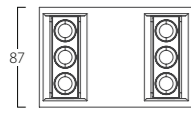

MC0725AS ^N

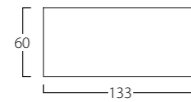
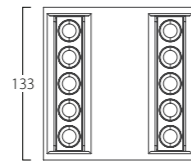

UNIT: mm

TECHNICAL DETAILS

Material
aluminium

Electrical connection
on/off

Optical system
opal diffusor

Control

Light source
LED COB

Color
○

Light distributions

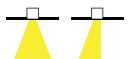

INFORMATION

MC0703AS



Power	Beam angle	CCT	Flux	CRI	Cut-out	Power supply
3x2W	15°	2700K	300lm	95+		9V, 500mA
	24°	3000K				
	36°	3500K				
		4000K				

MC0705AS



Power	Beam angle	CCT	Flux	CRI	Cut-out	Power supply
5x2W	15°	2700K	500lm	95+		15V, 500mA
	24°	3000K				
	36°	3500K				
		4000K				

MC0710AS



Power	Beam angle	CCT	Flux	CRI	Cut-out	Power supply
10x2W	15°	2700K	1000lm	95+		30V, 600mA
	24°	3000K				
	36°	3500K				
		4000K				

MC0723AS



Power	Beam angle	CCT	Flux	CRI	Cut-out	Power supply
6x2W	15°	2700K	600lm	95+		18V, 600mA
	24°	3000K				
	36°	3500K				
		4000K				

MC0725AS



Power	Beam angle	CCT	Flux	CRI	Cut-out	Power supply
10x2W	15°	2700K	1000lm	95+		30V, 600mA
	24°	3000K				
	36°	3500K				
		4000K				



BIG DIPPE Spotlight



Four hole fixed concentrated light, deep anti glare light, soft and comfortable, high brightness. It has hoisting, surface installation and embedded installation methods, which are suitable for various decoration styles.



BIG DIPPER



MC0104FS N

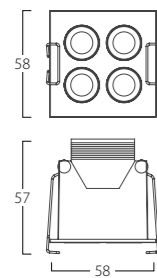

50x50



MC07060L N

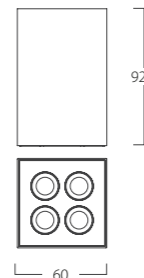



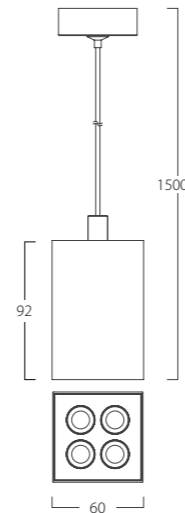

MC07060L N



UNIT: mm

INFORMATION

MC0104FS

Power	Beam angle	CCT	Flux	CRI	Cut-out	Power supply
4x2W	15°	2700K	400lm	95+		12V, 550mA
	24°  	3000K				12V, 550mA
	36°  	3500K				12V, 550mA
		4000K				12V, 550mA
		2700K-6000K				24V, 300mA

MC07060L

Power	Beam angle	CCT	Flux	CRI	Cut-out	Power supply
4x2W	15°	2700K	400lm	95+		12V, 550mA
	24°	3000K				
	36°	3500K				
		4000K				

MC07060L

Power	Beam angle	CCT	Flux	CRI	Cut-out	Power supply
4x2W	15°	2700K	400lm	95+		12V, 550mA
	24°	3000K				
	36°	3500K				
		4000K				

TECHNICAL DETAILS



Material aluminium 铝合金	Electrical connection on/off
Optical system opal diffusor	Control -
Light source LED COB	Color ○ 哑白

Light distributions



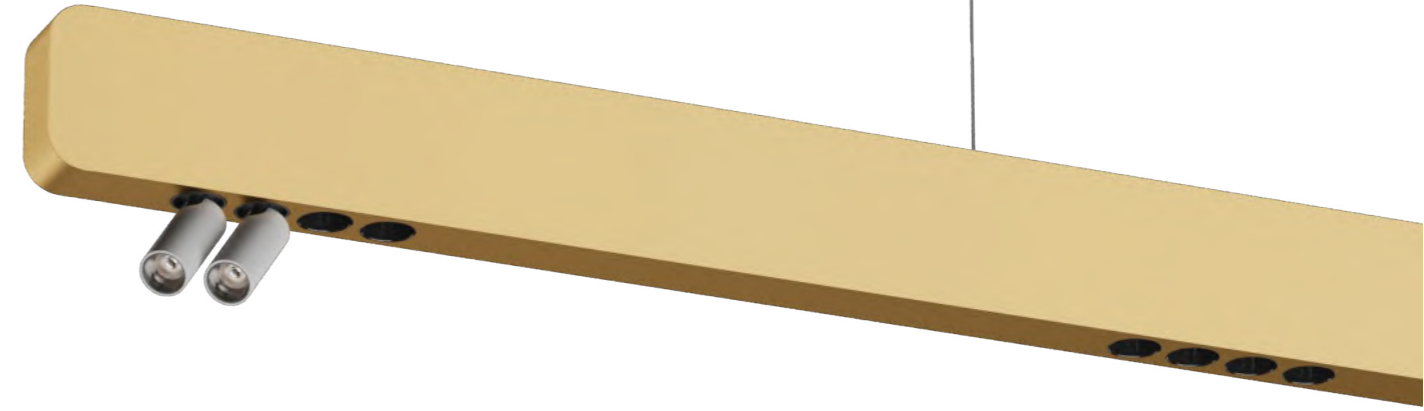

The minimalist shape and comfortable anti glare optical structure create a natural and pleasant light environment for you.

CUSTOMIZATION DESIGN

Fixed / Adjustable
Different modules can be customized according to customer needs.



Gold



White



Black

BIG DIPPER

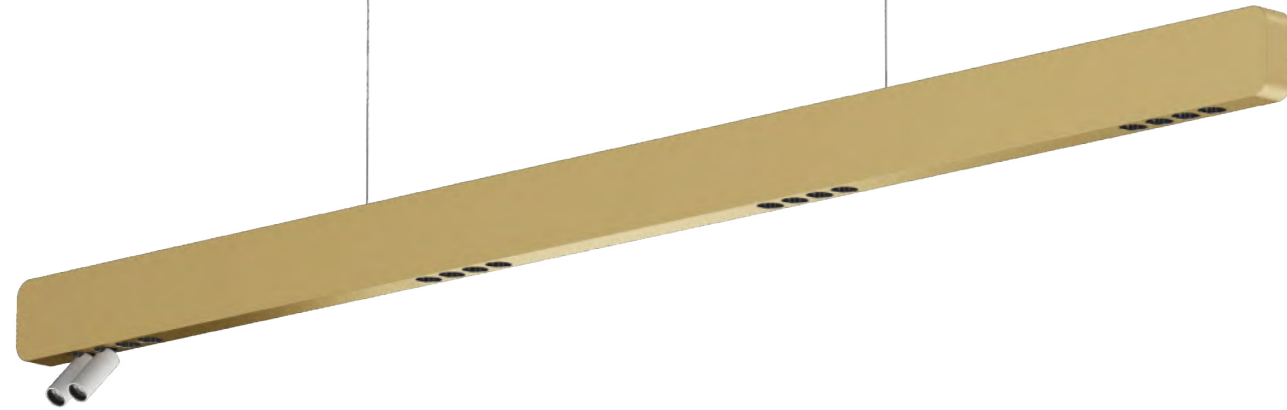

MC07120L

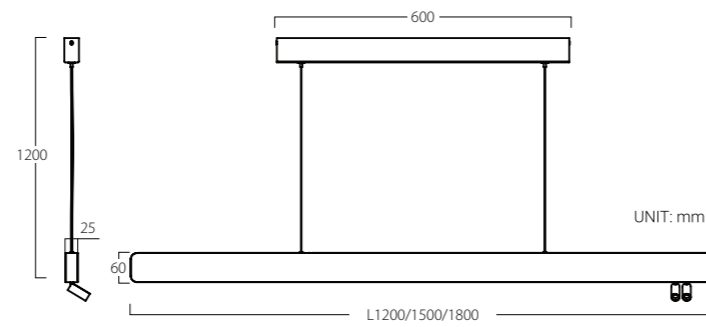

INFORMATION

MC07120L

Power	Beam angle	CCT	Flux	CRI	Size	Power supply
40W	24°	3000K	2000 lm	95+	1200×25×60mm	12V, 3.2A

MC07150L

Power	Beam angle	CCT	Flux	CRI	Size	Power supply
40W	24°	3000K	2000 lm	95+	1500×25×60mm	12V, 3.2A

MC07180L

Power	Beam angle	CCT	Flux	CRI	Size	Power supply
40W	24°	3000K	2000 lm	95+	1800×25×60mm	12V, 3.2A

TECHNICAL DETAILS

- Material**
aluminium
- Electrical connection**
on/off
- Optical system**
opal diffuser
- Control**
- Light source**
LED COB
- Color**

Light distributions

